

SAFETY MATS

The pressure-sensitive mat is a “safety device” which features an electro-pressure sensible element to detect the presence of persons.

The presence of one or more persons over 35 kg closes a contact inside the sensor.

The change in state of the internal sensor (NO to NC) is processed by the control unit which emits a machine stop signal and removes the hazardous situation.

HOW TO DIMENSION A SAFETY MAT

The minimum distance from the hazardous area shall be calculated with the general formula:

S = Minimum distance (in mm) from the hazardous area to the point, the axis, the surface or the detection zone

T = Global response time in seconds

$$S = (K \times T) + C$$

K = Constant expressed in millimetres/seconds, resulting from data on the approach speed of the human body or parts of the body

C = Additional distance in millimetres based on the intrusion into the hazardous area before the activation of the safety device

CALCULATION OF MINIMUM DISTANCE FOR SAFETY DEVICES INSTALLED ON THE FLOOR

GENERAL METHOD

The choice and use of safety devices installed on the floor, activated by foot, depend upon the appropriate type-“C” Safety Standard or upon the evaluation of risks in conformity with the EN ISO 12100 Standard if a type-“C” Safety Standard does not exist.

Examples of sensible devices installed on the floor include pressure-sensitive safety mats, pressure-sensitive platforms and optoelectronic protection devices.

The minimum distances derived in this point for sensitive floor-mounted devices require that the approaching speed to the hazardous area is the walking speed. As for the risk of bypassing the detection area, please refer to the Appendix B (EN ISO 13855 Standard). The minimum distance is to be calculated with the following formula:

S = Minimum distance (in mm) of the hazardous area from the point, the axis, the surface or the detection zone

T = Global response time in seconds

$$S = (1600 \text{ mm/s} \times T) + (1200 \text{ mm} - 0.4 H)$$

H = distance in millimetres over the reference plan, e.g. the floor.

FLOOR-MOUNTED INSTALLATION

In most cases, the sensitive device is installed directly on the floor, that is $H = 0$. Therefore, the minimum distance for pressure sensitive devices installed on the floor shall be calculated with the following formula:

S = Minimum distance (in mm) of the hazardous area to the point, the axis, the surface or the detection zone

$$S = (1600 \text{ mm/s} \times T) + 1200 \text{ mm}$$

T = Global response time in seconds

Example

Approach direction to the detection zone.

This minimum distance shall be calculated with the following formula:

$$S = (K \times T) + C$$

Where: **K** = 1600 mm/s

C = 1200 mm - 0.4 H, but not less than 850 mm, where H is the height of the detection area over the reference plan, e.g. the floor (in mm).

Namely: $S = (1600 \text{ mm/s} \times T) + (1200 \text{ mm} - 0.4 H)$

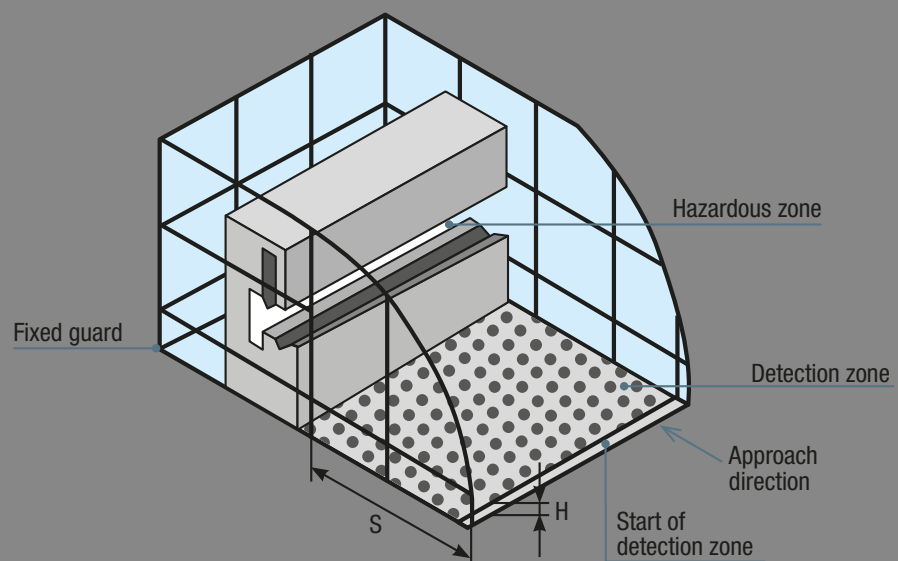

H Height of the detection area on the reference plan

S Minimum distance

STANDARD SAFETY MAT EMBOSSSED PVC, BLACK

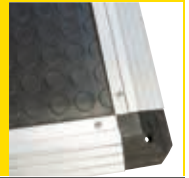

The safety mat is supplied with an embossed, **black PVC coating** (other colours available upon request).

The safety mat can be divided in **two sensitive zones** controlled by two separate circuits (e.g.: door opening in the presence of a person or in front of an ATM machine). In this case, if both zones are simultaneously activated, the two signals cause the installation to shut-down.

The safety mat can be supplied **mounted on a plate** in order to allow it to be positioned on a non-perfectly flat floor or on a grating support. Maximum dimensions of the single mat: 2000x1500 mm. Zones with larger dimensions can be formed by placing several mats side by side. The safety mat can be supplied with already mounted Aluminium profiles or with loose profiles cut to measure.

WITH ALREADY MOUNTED ALUMINIUM PROFILES

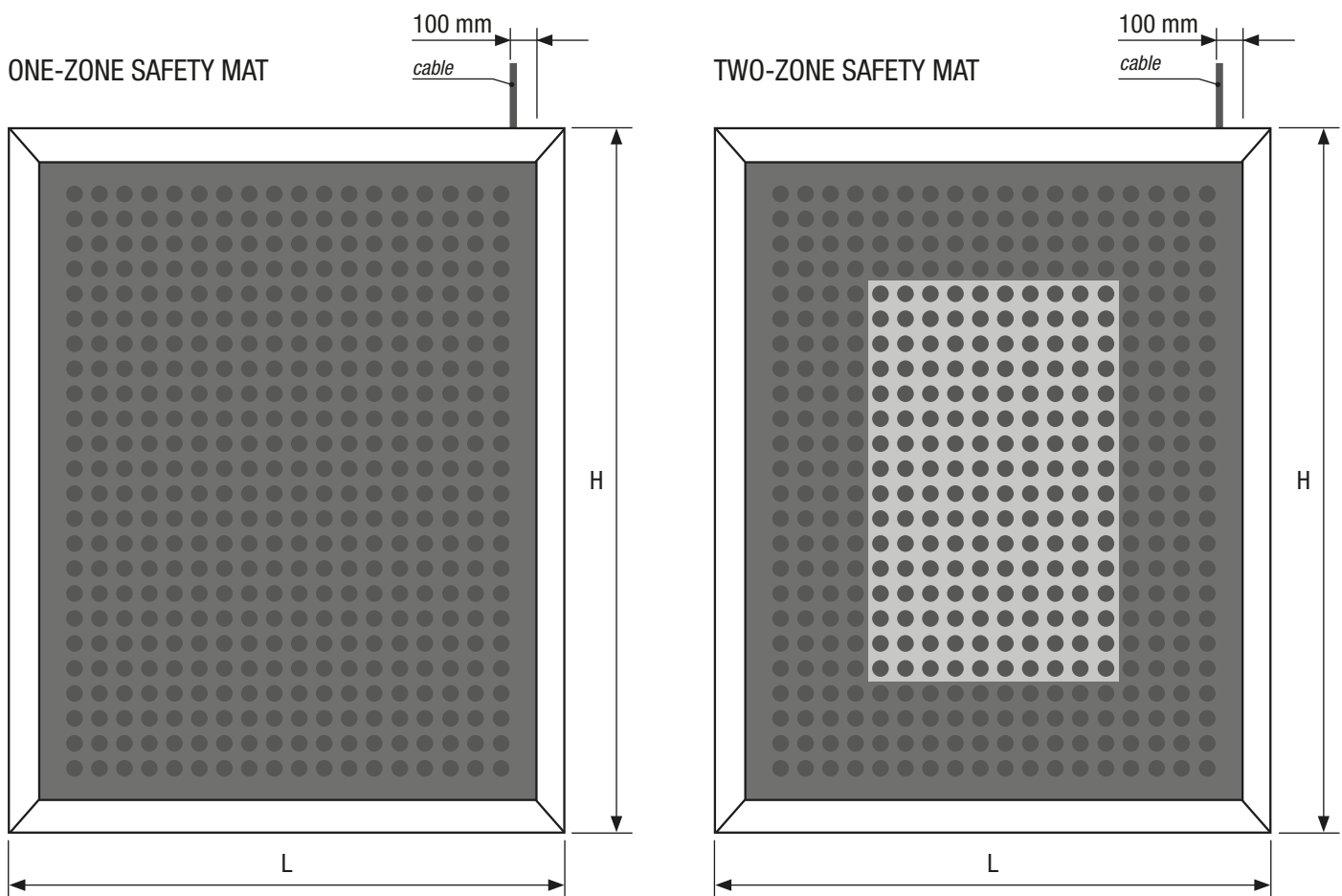

The safety mat is equipped with a 4-pole, FROR 300/500, outlet cable (4x0.35mm²) – standard length 3 m - placed at a distance of 100 mm from the right edge.

HOW TO ORDER A SAFETY MAT WITH MOUNTED PROFILES

The overall dimensions of the safety mat with mounted profiles **always include the contouring profiles**.

Always attach a drawing of the safety mat, indicating the dimensions (**L=width x H=Height**), type of profiles and cable outlet position, if other than the standard one.

Code

GSTS = Gamma System Safety Mat

L x H = Width x Height (mm)

GSTSPPM _ _ _ _ **X** _ _ _ _

P = Embossed PVC coating, black

PM = Mounted profile

Cable = X: standard

1: special version

GSTSPPM **DZ** _ _ _ _ **X** _ _ _ _

DZ = Two zones

INFORMATION REQUIRED FOR COMPLETING THE SAFETY MAT

- **Type of A or B profiles**, the aluminium profiles are fastened to the perimeter area of the mat (dead zone) by means of rivets. If both the slope type and 90° type profiles are used, please attach a drawing indicating the position.
- **Length and position of cable if other than the standard one (3 m).**

PROFILES

Type "A" | Slope profile | 45 mm footprint

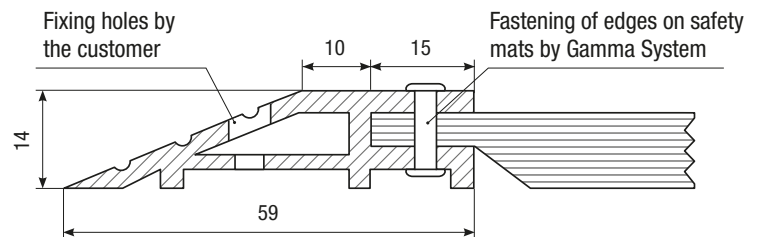

Type "B" | 90° profile | No footprint

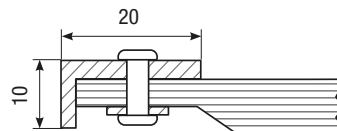

CABLE

X: CS_ Standard Cable, 4x0.35mm² – 3 m in length, without connector

1: Special version:

CSM8M: standard cable with male connector, 4 poles M8

CSCKM03V: standard cable with connector type ILME .

CKM03VG: standard cable with connector type ILME .

In case of length other than the standard one, please indicate the cable length, e.g. 10 m = **C10**.

Example 1: Code terminating with an X Safety mat with mounted profiles and with the following dimensions: 1000x1000 mm with slope profile on the 4 sides and standard cable outlet.

GSTSPPM1000x1000X

(Type "A" profile) sensitive area 910x910 mm.

Example 2: Code terminating with an X1 Special version of the safety mat with mounted profiles and with the following dimensions: 1400x750 mm with 90° profile on the 4 sides and standard cable outlet with Connector type ILME

GSTSPPM1400x750X1

(Type "B" profile, cable CSCKM03V), sensitive area 1310x660 mm.

WITH ALUMINIUM PROFILES SUPPLIED LOOSE

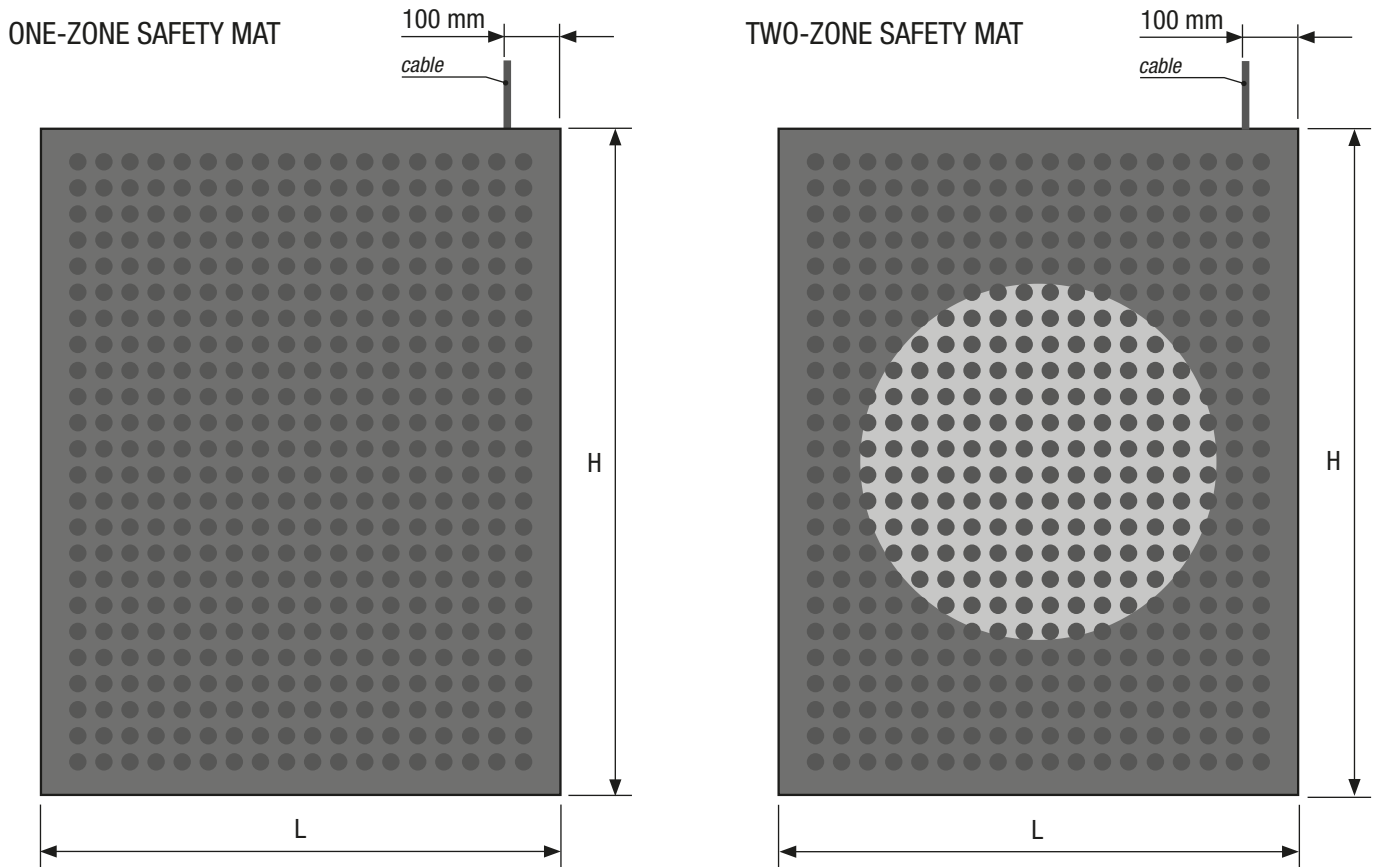

The safety mat is equipped with a 4-pole, FROR 300/500, outlet cable (4x0.35mm²) – standard length 3 m - placed at a distance of 100 mm from the right edge.

HOW TO ORDER A SAFETY MAT WITH PROFILES SUPPLIED LOOSE

By dimension of the safety mat with loose profiles, one always intends the dimension of the sensitive part, **profile dimensions excluded**. Please attach a drawing of the safety mat indicating the dimensions (**L = Width x H = Height**), type of profiles as well as the position of the cable outlet if other than the standard one.

Code

GSTS = Gamma System Safety Mat

L x H = Length x Height (mm)

G S T S P P S _ _ _ _ X _ _ _ _ _

P = Embossed PVC coating, black

PS = Loose profile

Cable = X: Standard

1: Special version

G S T S P P S D Z _ _ _ _ X _ _ _ _ _

DZ = Two zones

INFORMATION REQUIRED FOR COMPLETING THE SAFETY MAT

The aluminium profiles required for fastening the safety mat to the floor are supplied loose and cut to measure.

- **Aluminium profiles** shall be placed along the perimeter area of the safety mat (dead zone) and fastened to the floor by means of rivets. If different profiles are used, please attach a drawing indicating their position.
- **Length and position of cable if other than the standard ones.**

PROFILES

GSPS02 | Slope profile | Footprint 45 mm

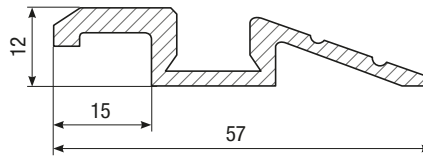

GSP90 | 90° profile | Footprint 15 mm

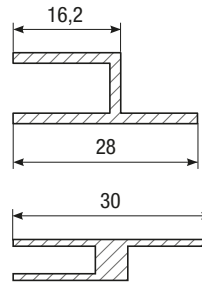

GSPAN [black] - GSPAG [yellow] | Coupling profile
Footprint 2 mm

GSAN | Corners | Footprint 45 mm

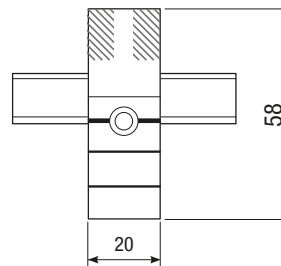

GSPANGSCRIP | Cable duct cross junction

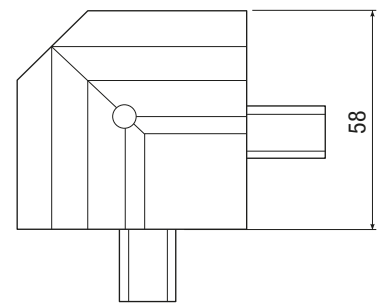

CABLE

X: CS - Standard Cable, 4x0.35 mm² – 3 m in length – without connector

1: Special version:

CSM8M: standard with male connector, 4 poles M8;

CSCKM03V: standard with connector type ILME;

CKM03VG: standard with connector type ILME with hook;

In case of length other than the standard one, please indicate the cable length, e.g. 10 m = **C10**.

Example: safety mat with loose profiles, double area, dimension 900x750 mm with standard cable outlet.

GSTSPPSDZ0900x750 (specify the type of profile)

HOW TO ORDER A SAFETY MAT WITHOUT PROFILES

By dimension of the safety mat, one always intends the dimension of the sensitive part.

Please attach a drawing of the safety mat indicating the dimensions (**L = Width x H = Height**) and the position of the cable outlet if other than the standard one.

GSTS = Gamma System Safety Mat

L x H = Width x Height (mm)

GSTSPSP _ _ _ _ **X** _ _ _ _

P = Embossed PVC coating, black

SP = Without profile

Cable = X: standard

1: special version

SAFETY MAT WITH ALMOND-SHAPED ALUMINIUM PROFILES



The safety mat can be supplied with aluminium profiles already mounted or supplied loose and cut to measure.

Maximum dimensions of the single safety mat: 2000x1500 mm.

WITH ALUMINIUM PROFILES ALREADY MOUNTED

The safety mat with aluminium profiles already mounted is always supplied installed on a galvanized steel sheet.

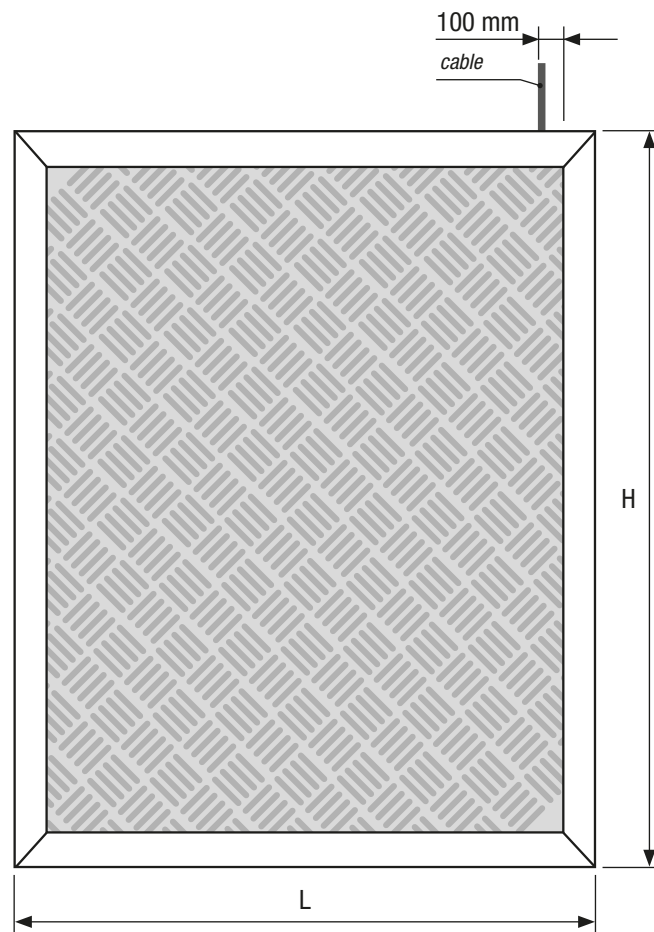

The safety mat is equipped with a 4-pole, FROR 300/500, outlet cable (4x0.35mm²) – standard length 3 m - placed at a distance of 100 mm from the right edge.

HOW TO ORDER A SAFETY MAT WITH ALREADY MOUNTED PROFILES

By dimension of the safety mat, **one always intends the overall dimensions**.

Please attach a drawing of the safety mat indicating the dimensions (**L = Width x H = Height**), the type of profiles and the position of the outlet cable if other than the standard one.

Code

GSTS = Gamma System Safety Mat

L x H = Width x Height (mm)

GSTSAPM _ _ _ _ **X** _ _ _ _

A = Almond-shaped aluminium
PM = Mounted profile

Cable = X: standard
1: special version

INFORMATION REQUIRED FOR COMPLETING THE SAFETY MAT

- The **aluminium profiles** are fastened along the perimeter area of the mat (dead zone) by means of rivets. If both the slope type and 90° type profiles are used, please attach a drawing indicating their position.
- **Length and position of cable if other than the standard one.**

PROFILES

Code "GSPSA" | Slope profile | Footprint 59 mm

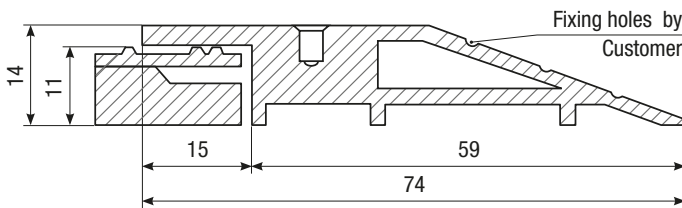

Code "GSP90A" | 90° profile | Footprint 17 mm

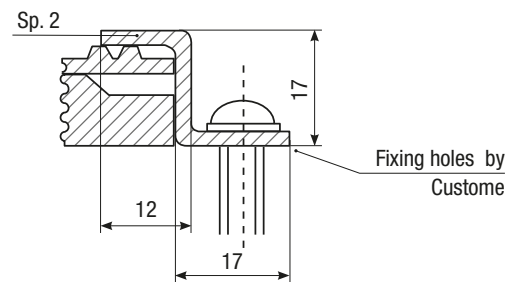

Code "GSTSAN..1" | Corners | Footprint 45 mm

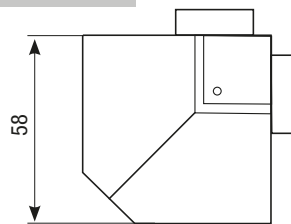

Code "GSTSPCALL" | Cable duct cross junction

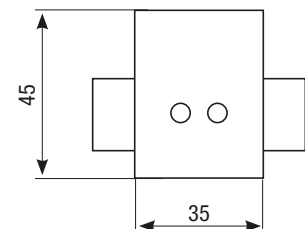

CABLE

X: CS – Standard Cable, 4x0.35 mm² - 3 m long, without connector

1: Special version:

CSM8M: standard with Male connector, 4 poles M8;

CSCKM03V: standard with connector type ILME;

CKM03VG: standard with connector type ILME, with hook;

In case of length other than the standard one, please indicate the cable length, e.g. 10 m = **C10**.

Example: safety mats with mounted profiles, dimensions 1000x1000, with slope profile on 4 sides and with standard cable outlet.

GSTSAPM1000x1000X (profile type "GSPSA") sensitive area 800x800 mm

WITH ALUMINIUM PROFILES SUPPLIED LOOSE

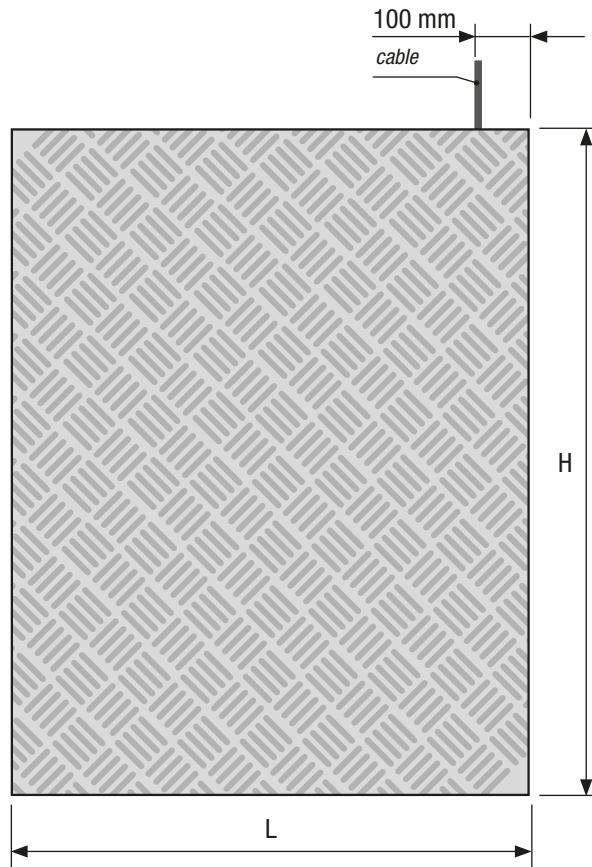

The safety mat is equipped with a 4-pole, FROR 300/500, outlet cable (4x0.35mm²) – standard length 3 m - placed at a distance of 100 mm from the right edge.

HOW TO ORDER A SAFETY MAT WITH LOOSE PROFILES

By dimension of the safety mat with loose profiles, one always intends the **dimension of the sensitive part, profile dimensions excluded**. Please attach a drawing of the safety mat indicating the dimensions (**L = width x H = Height**), type of profiles as well as the position of the cable outlet if other than the standard one.

Code

GSTS = Gamma System Safety Mat

L x H = Width x Height (mm)

G S T S A P S _ _ _ _ X _ _ _ _ _

A = Almond-shaped aluminium

PS = Loose profile

Cable = X: standard

1: special version

INFORMATION REQUIRED FOR COMPLETING THE SAFETY MAT

The aluminium profiles required to fasten the safety mat are supplied loose and cut to measure.

- **Aluminium profiles** shall be positioned along the perimeter area of the safety mat (dead zone) and fastened to the floor by means of rivets. If both the slope type and 90° type profiles are used, please attach a drawing indicating their position.
- **Length and position of cable if other than the standard one.**

PROFILES

Profiles are fastened along the perimeter area of the steel plate by means of rivets. If both the slope type and 90° type profiles are used, please indicate the profile and the position.

Code "GSPSA" | Slope profile | Footprint 59 mm

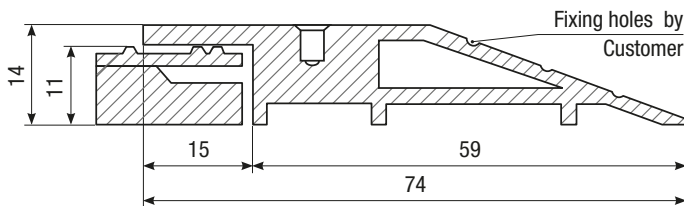

Code "GSP90A" | 90° profile | Footprint 17 mm

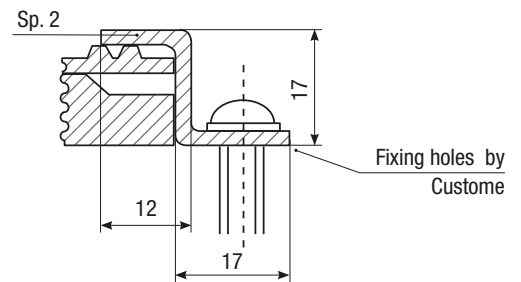

Code "GSTSAN..1" | Corners | Footprint 45 mm

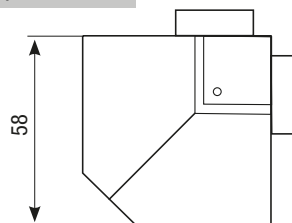

Code "GSTSPCALL" | Cable duct cross junction

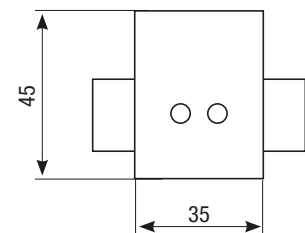

CABLE

X: CS - Standard cable, 4x0.35 mm² 3 m long, without connector

1: Special version:

CSM8M: standard with Male connector, 4 poles M8;

CSCKM03V: standard with connector type ILME;

CKM03VG: standard with connector type ILME with hook;

In case of length other than standard one, please indicate the cable length, e.g. 10 m = C10.

Example: safety mat with loose profiles and dimensions 1000x1000 with slope profile on 4 sides with standard cable outlet.

GSTSA**PS****1000****x****1000****X** (profile type "GSPSA") max. footprint of the area 1120 x1120 mm

HOW TO ORDER THE SENSITIVE PART ONLY

Code

GSTS = Gamma System Safety Mat

GSTSA**PS** _ _ _ _ **X** _ _ _ _

A = Almond-shaped aluminium

SPS = Sensitive part only

MODULAR SAFETY MAT EMBOSSED PVC



Safety mat supplied with **PVC** coating only.

Dimensions and standard arrangement (as per drawing) and profiles supplied loose.

Modular version conceived to solve problems of transport, handling and installation.

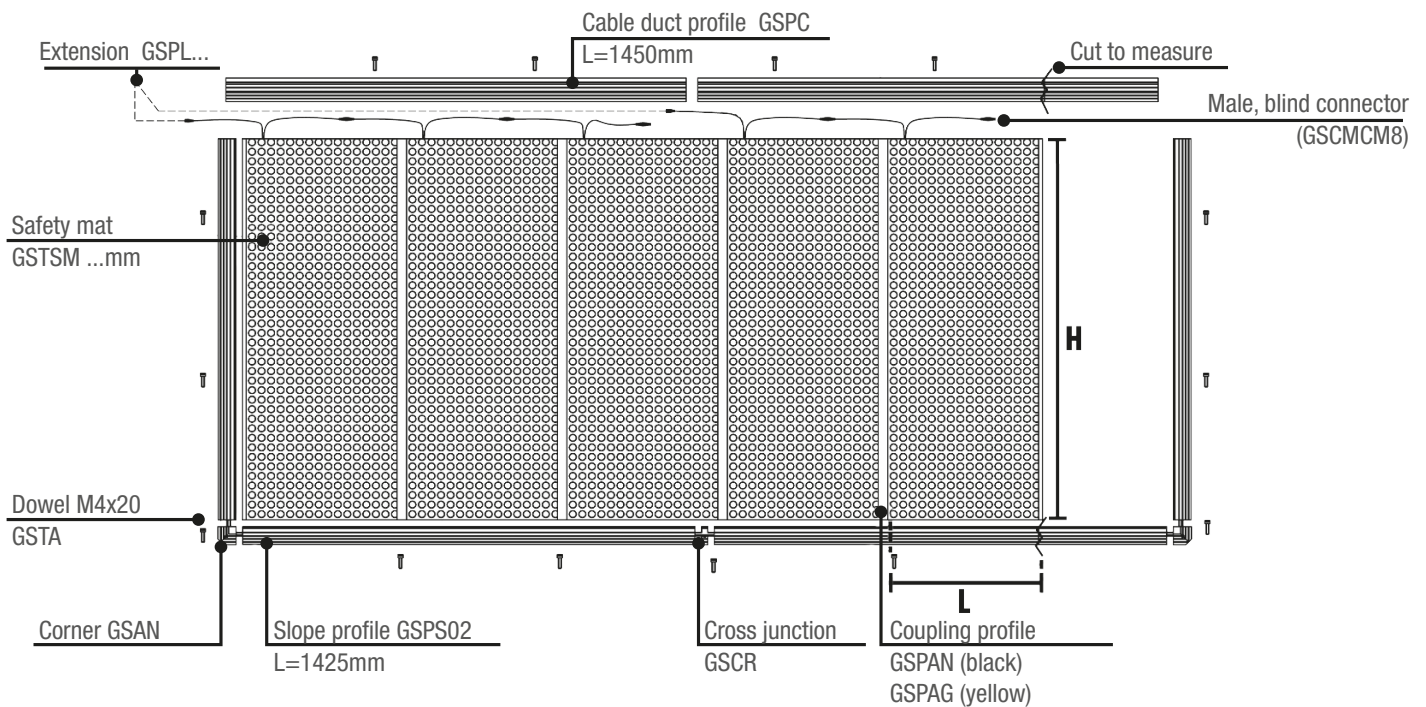

HOW TO ORDER A MODULAR SAFETY MAT

As for the modular version of the safety mat, the **dimension is the sensitive part of the mat, profile dimensions excluded**. Please attach a drawing of the safety mat indicating the dimensions ($L = \text{Width} \times H = \text{Height}$), type of profiles and their position. The mat is supplied with 2 outlet cables $L=600\text{ mm}$ 4 poles, $4 \times 0.25\text{mm}^2$ CEI IP65. One is equipped with an M8 MALE connector and the other with an M8 FEMALE connector for connecting the mats in series.

Code

GSTS = Gamma System Safety Mat

$L \times H = \text{Width} \times \text{Height (mm)}$

GSTSPM _ _ _ _ **X** _ _ _ _ **XX**

P = PVC

M = Modular type

INFORMATION REQUIRED FOR COMPLETING THE SAFETY MAT

The **aluminium profiles** required to fasten the mat are supplied loose and must be ordered separately.

- The aluminium profiles shall be placed along the perimeter area of the safety mat (dead zone) and fastened to the floor by means of rivets. If both the slope type and 90° type profiles are used, please attach a drawing indicating their position.

- **Electrical connection between the mat and the control device**

An extension with an M8 FEMALE connector (code GSPL – standard length 1000-3000-5000-7000-10000 mm) is to be purchased for connecting the mat to the control device. For closing the electric circuit of the last mat, an M8 Male connector (code GSCMCM8) is to be purchased.

(Example: mat area to be divided in two separate zones = n. 02 GSCMCM8 + n. 02 GSPL3500)

PROFILES AND ACCESSORIES

Code “GSPS02” | Slope profile | Footprint 45 mm
Standard length L = 1425 mm

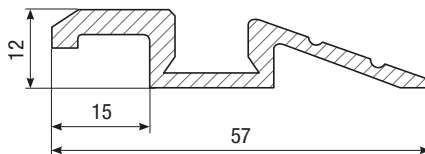

Code “GSPC” | Cable duct profile | Footprint 74 mm
Standard length L = 1450 mm

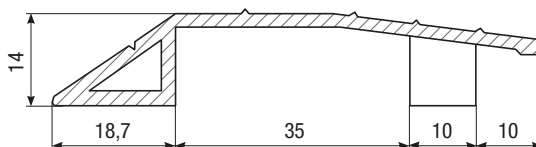

GSP90 | 90° profile | Footprint 15 mm

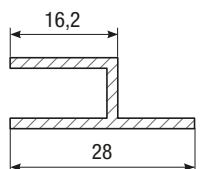

GSPAN [black] - GSPAG [yellow] | Coupling profile
Footprint 2 mm

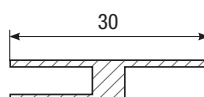

GSAN | Corners | Footprint 45 mm

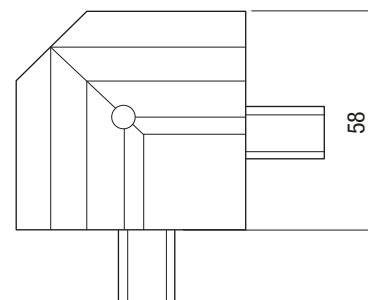

GSCR | Cross junction | Pack of 5 pcs.

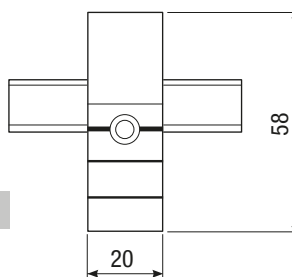

GSCR P | Cross junction with cable duct

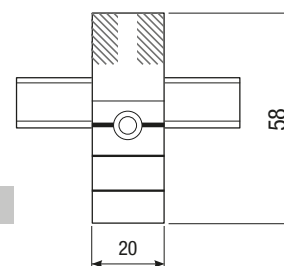

GSTA | Anchoring dowels | Pack of 10 pcs.



Code “GSCMCM8” | Connector for circuit closing (Male)



Extensions for mat connection to the control device

- Code “GSTSPL 3000”** | Cable length 3 m
- Code “GSTSPL 5000”** | Cable length 5 m
- Code “GSTSPL 7000”** | Cable length 7 m
- Code “GSTSPL 10000”** | Cable length 10 m

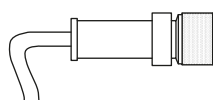

M8 Female 4P

Example: Modular safety mat with dimensions 1000x1500 mm (profile type “GSPS02”) maximum footprint 1090x1590 mm.

GSTSPM1000x1500XX

TECHNICAL FEATURES OF THE GSTS SENSOR

Sensor	Mat with PVC coating		Coating with PVC+ALUMINUM
Max thickness [mm]	10		14
Weight/m ² [kg]	15 (approx.)		22 (approx.)
Operating pressure	< 300 N Ø mm 80 / < 600 N Ø mm 200		
Max admissible load	2000 N / 80 Ø mm (avoid manoeuvres with heavy means such as lift trucks, motor vehicles and like)		
Response time with Gamma System control units	Single sensor: ≤ 60 ms Combination of sensors: ≤124 ms		
Mechanical life of internal contact	2.000.000 operations		
PFH (mat)	4.29*10 ⁻⁸		
Max operating voltage	24 Vdc/ac		
Max operating current	60 mA / 24 V		
Electric resistance of sensor m ² [Ω/m ²]	1.7		
Linear resistance of cable [Ω/m]	0.056		
Max connection length [m]	100		
Connection cable section	min. 0.35 mm ² For cables with L>20 m min. 1 mm ²		
Outlet contact	NO		
Operating temperature	+5°C to +60°C		
Storage temperature	+5°C to +60°C		
Degree of protection	IP65		
Chemical resistance	Oils, hydrocarbons		
B _{10D}	2.000.000		
Max dimensions of each safety mat [mm]	1500 x 2000		
Dead zone	Welding peripheral zone 15 mm		
Reference Standards	EN ISO 13856-1:2013, EN ISO 13849-1		
Safety Parameters: Sensor + Control Unit	GSTS01 + GP02/E	GSTS01 + GP02R.T	GSTS01 + GP04T
Category	3	3	3
PL	d	d	d
PFH _D [1/h]	9.23*10 ⁻⁸	8.58*10 ⁻⁸	9.29*10 ⁻⁸
No. of operations/year max.	80000		100000
Usage categories	DC13 – 1,5A	AC15 – 1,2A	-
T _{10D} [years] control unit *	9.25	12.5	-
Max controllable surface [m ²]	5	10	
CE Declaration	21CMAC0015		
Other European Directives			
2012/19/UE	RAEE		
2011/65/UE	ROHS		
Regulation (CE) n°1907/2006	REACH		

* Considered with max number of operations. Once the time indicated on data sheet above has elapsed, contact Gamma System After-Sale Service.

